

**MOTTO**<sup>®</sup>  
Tiles & Bathware

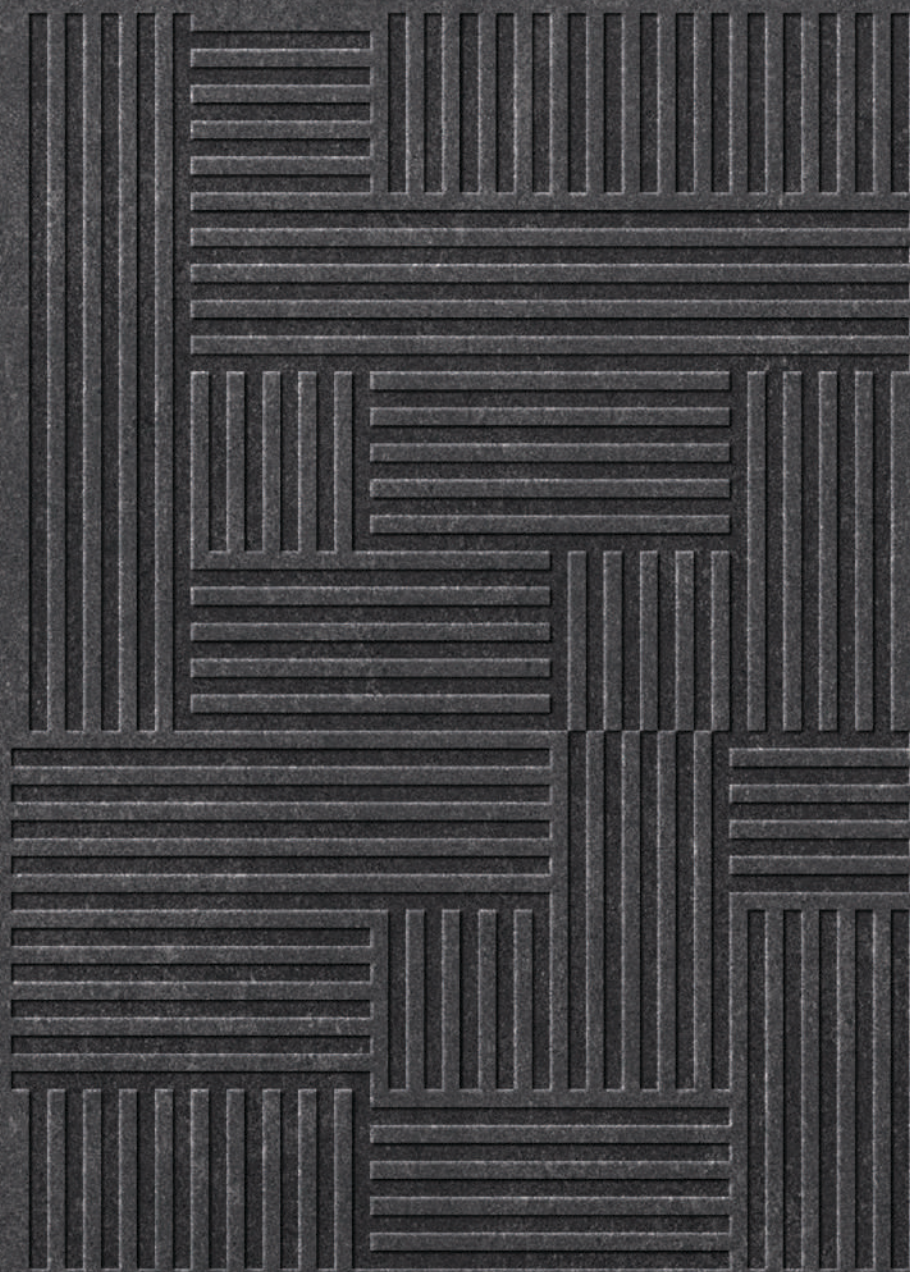

**MILESTONE**  
SERIES

**800x1600mm**

9mm Thickness



## About Company

Motto is one of the most dynamic & productive brands of the modern ceramic world that is brought to life by a visionary person Mr. Mahendra Patel. Over the years the company has developed manyfold.

Since 2004 - the inception year, to today we have expanded our reach to national & international arenas with a capillary presence in more than 70+ countries with 2500 satisfied customers.

Finest skills clubbed with state of the art technology have helped us to carve a niche, which is stamped by authorities as we are ISO 9001 : 2018 Certified. Overall the company has marked its position as the leading Manufacturer, Exporter and Supplier of the exquisite Ceramic Porcelain Tiles for Wall & Floor.



## Unparalleled Resistance That Leaves A Lasting Impact

Made from high-quality materials, these **GHR surfaces** are built to endure heavy foot traffic, harsh weather conditions, and general wear, making them a long-lasting and reliable choice for both flooring and wall applications.

Crafted with advanced technology, these surfaces ensure long-lasting performance while maintaining their aesthetic appeal over time.

Suitable for both residential and commercial spaces, these GHR Surfaces add a lasting touch of ingenuity to your space while boosting resilience in the highest manner.

## Durability That Stays Unbounded By Time



**800x1600mm**  
9mm Thickness

# An Approach That's Environmentally Conscious

By opting for environmentally friendly options, we help in preserving the natural resources while creating healthier spaces.



**Where Style  
Meets  
Responsibility**

Our surfaces are crafted using natural raw materials, seamlessly blending eco-friendliness with exceptional durability. This combination ensures that each surface is not only environmentally responsible but also built to withstand the test of time, providing long-lasting performance without compromising on sustainability.

# Application Areas

Powered with features that make these surfaces an amicable choice for vivid spaces while narrating a touch of style.



Door / Window Frame

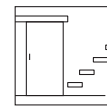

Stair Case

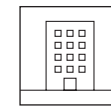

Commercial Areas

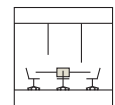

Dining Area

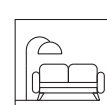

Flooring



Bathroom Vanities

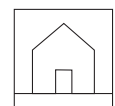

Exterior Wall Cladding

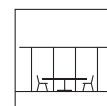

Café & Restaurant

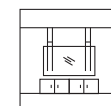

TV Room



## High Resilience

The surfaces are resilient to stains, scratches, impacts, and more.



## Anti-bacterial Surface

Non-porous surfaces boost anti-microbial properties, making them hygienic.



## Sustainable

The practices at Motto are designed green to promote sustainability.



## Made in India

The products of Motto are proudly Made in India and available worldwide.



## Heat & Weather-Resistant

The robust surfaces stay unaffected by heat and harsh weather conditions.



## Recyclable

Made thoughtfully, the surfaces are recyclable, generating less waste.

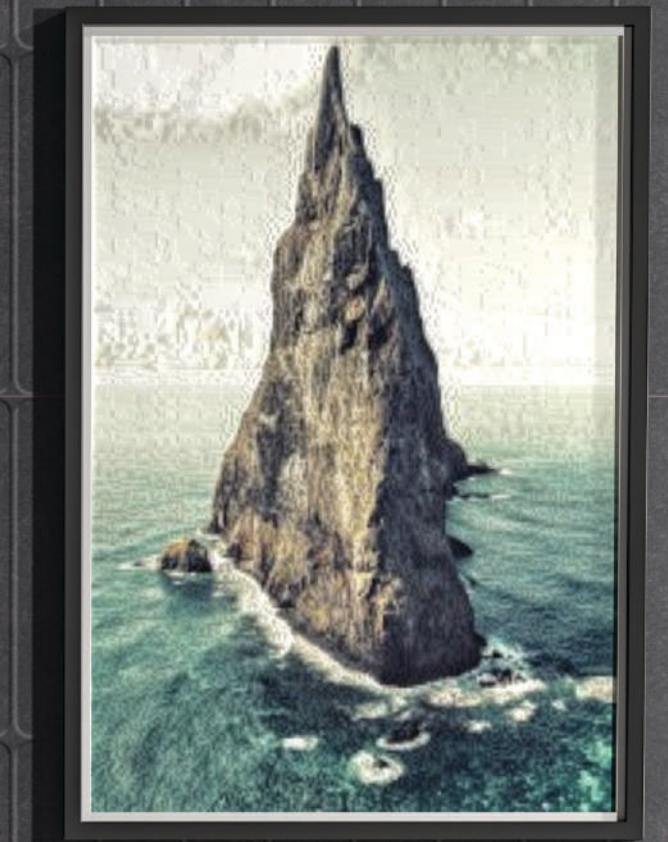

**Punch**  
Milestone Gris



**Plain**  
Milestone Bianco

# Table of Contents

Milestone Bianco  
800x1600mm

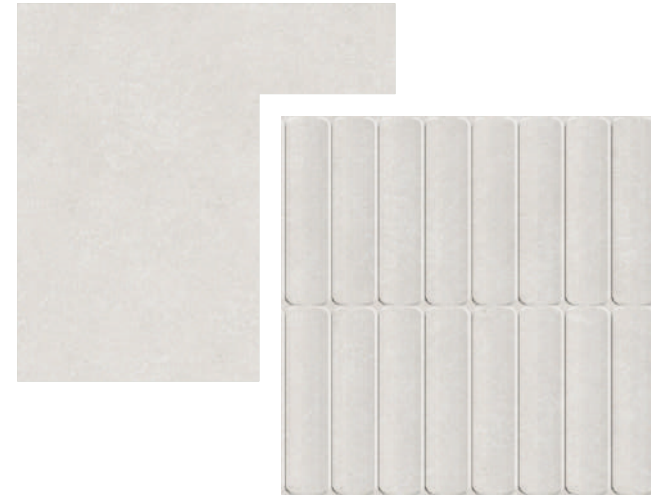

Milestone Grey  
800x1600mm

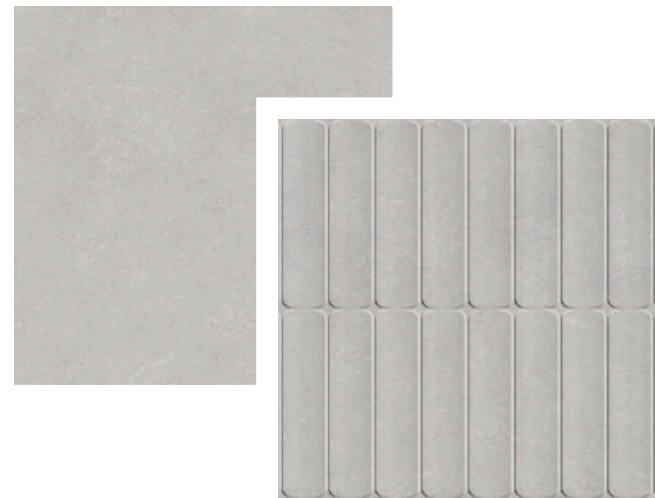

Milestone Gris  
800x1600mm

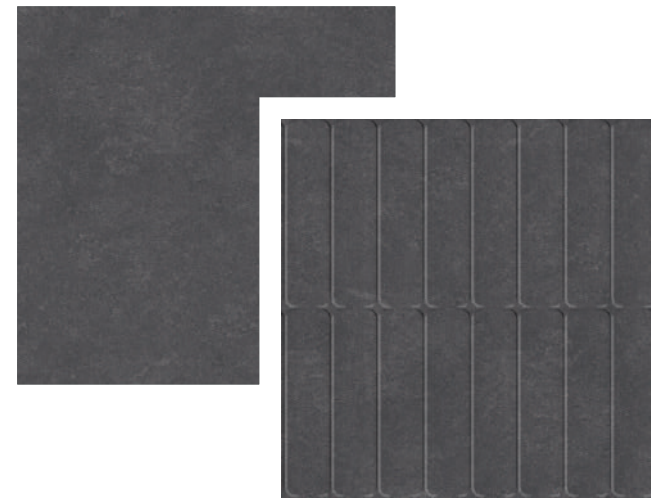

Milestone Crema  
800x1600mm

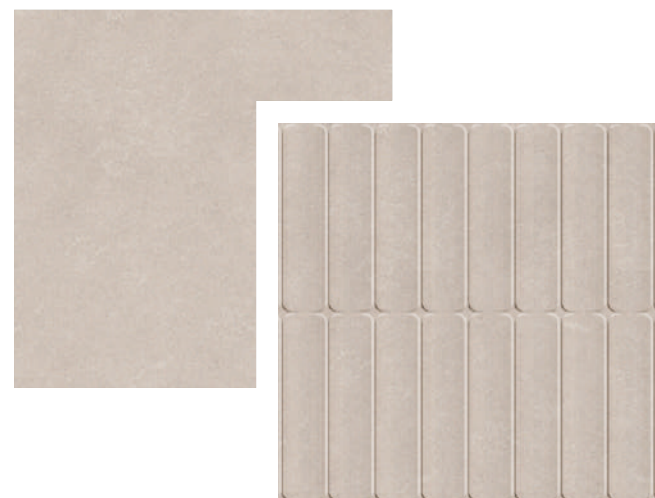

Statuario Verona  
800x1600mm

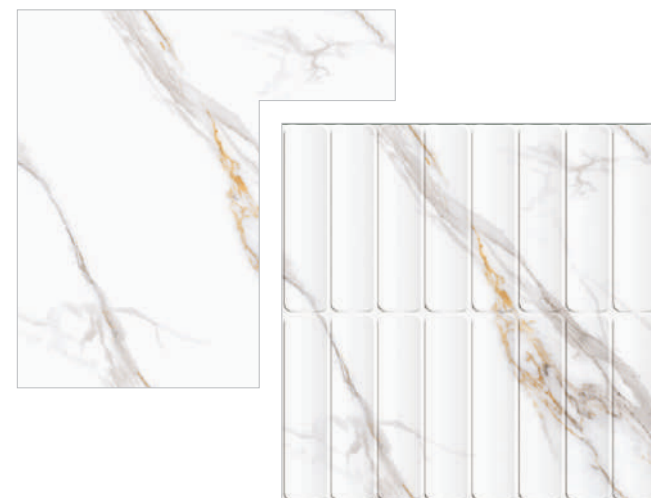

An Exclusive Touch Of  
Fine Craftsmanship



Milestone Bianco Decor

GHR + Punch



Milestone Bianco

GHR



800x1600mm / 32"x64"  
9mm Thickness



Wall\_Milestone Bianco (Punch)  
Floor\_Milestone Bianco



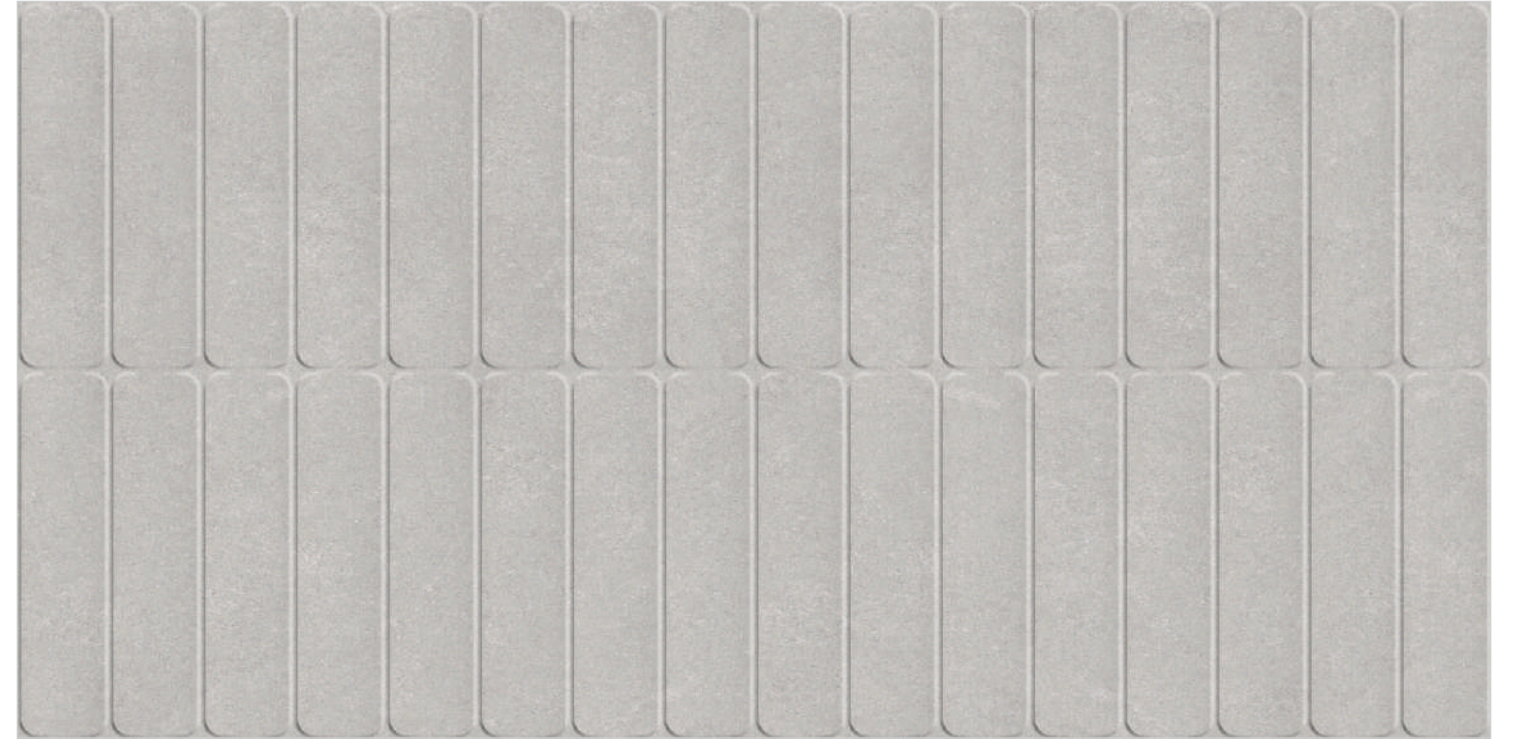
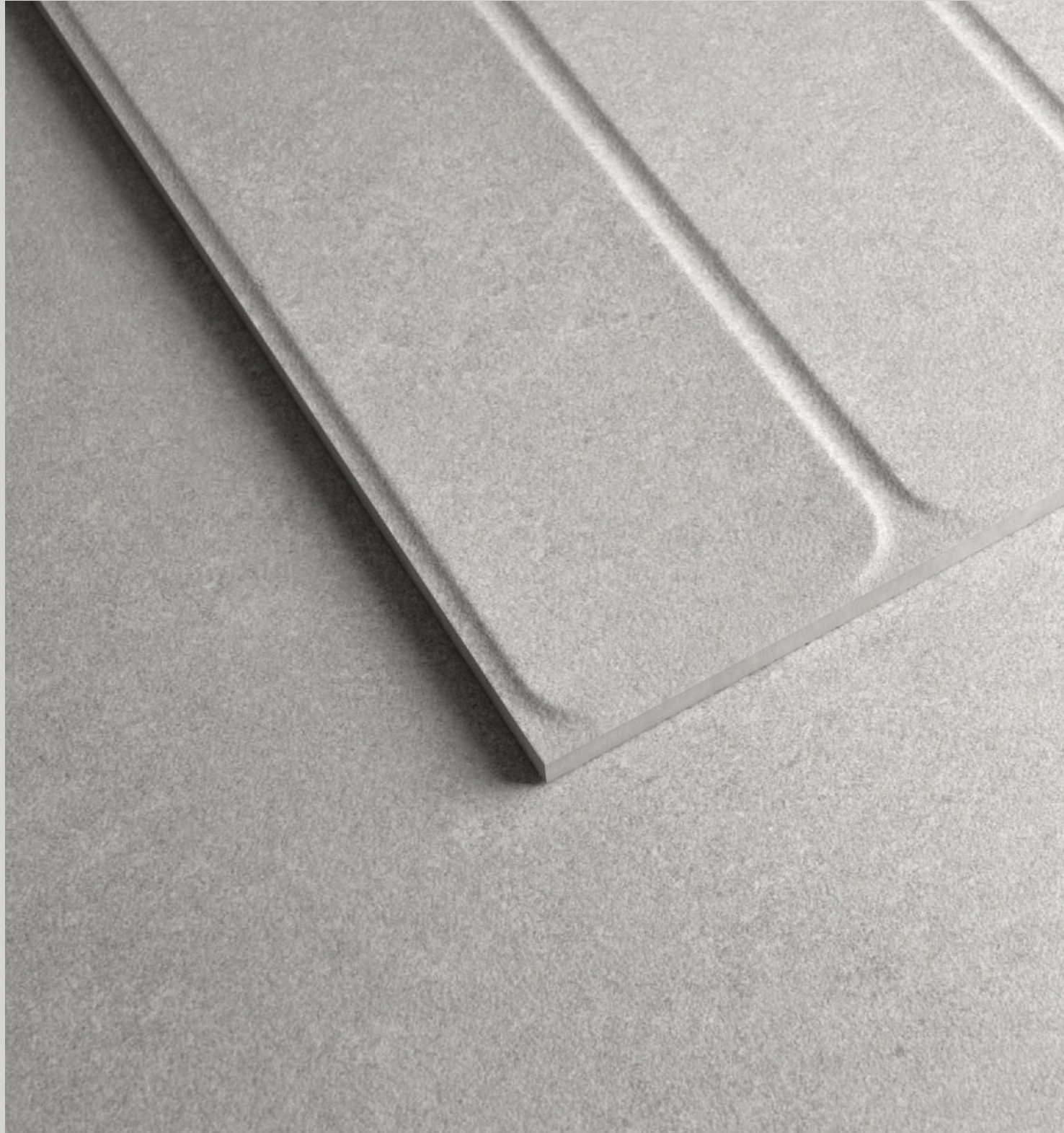

Milestone Grey Decor

GHR + Punch



Milestone Grey

GHR



800x1600mm / 32"x64"  
9mm Thickness



Wall\_Milestone Grey (Punch)  
Floor\_Milestone Grey

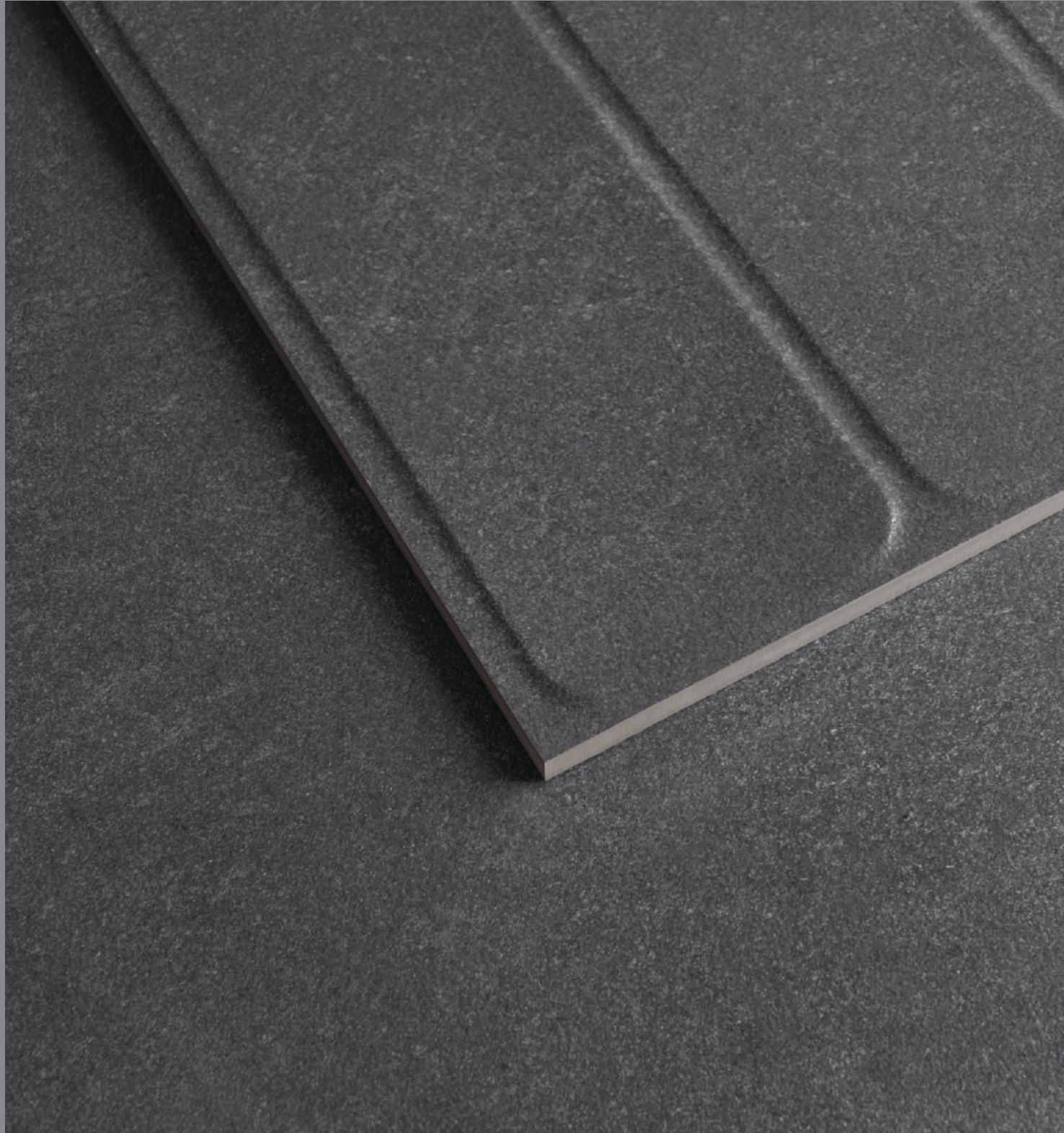

Milestone Gris Decor

GHR + Punch



Milestone Gris

GHR

SCAN FOR  
VIRTUAL  
360°



800x1600mm / 32"x64"  
9mm Thickness



Wall\_Milestone Gris (Punch)  
Floor\_Milestone Gris

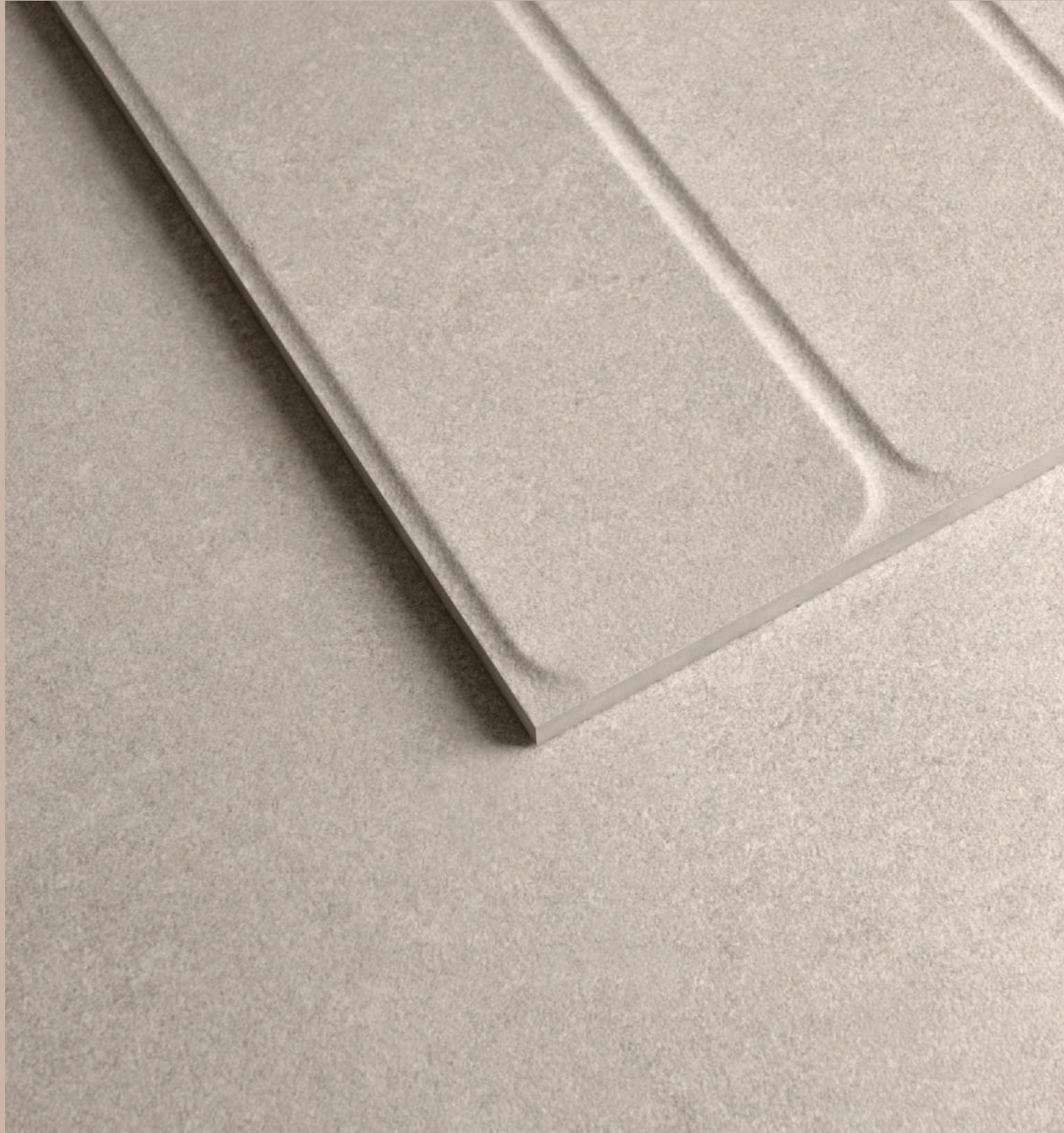

Milestone Crema Decor

GHR + Punch



Milestone Crema

GHR



800x1600mm / 32"x64"  
9mm Thickness



Wall\_Milestone Crema (Punch)  
Floor\_Milestone Crema



**ENDLESS**



Statuario Verona Decor

GHR + Punch

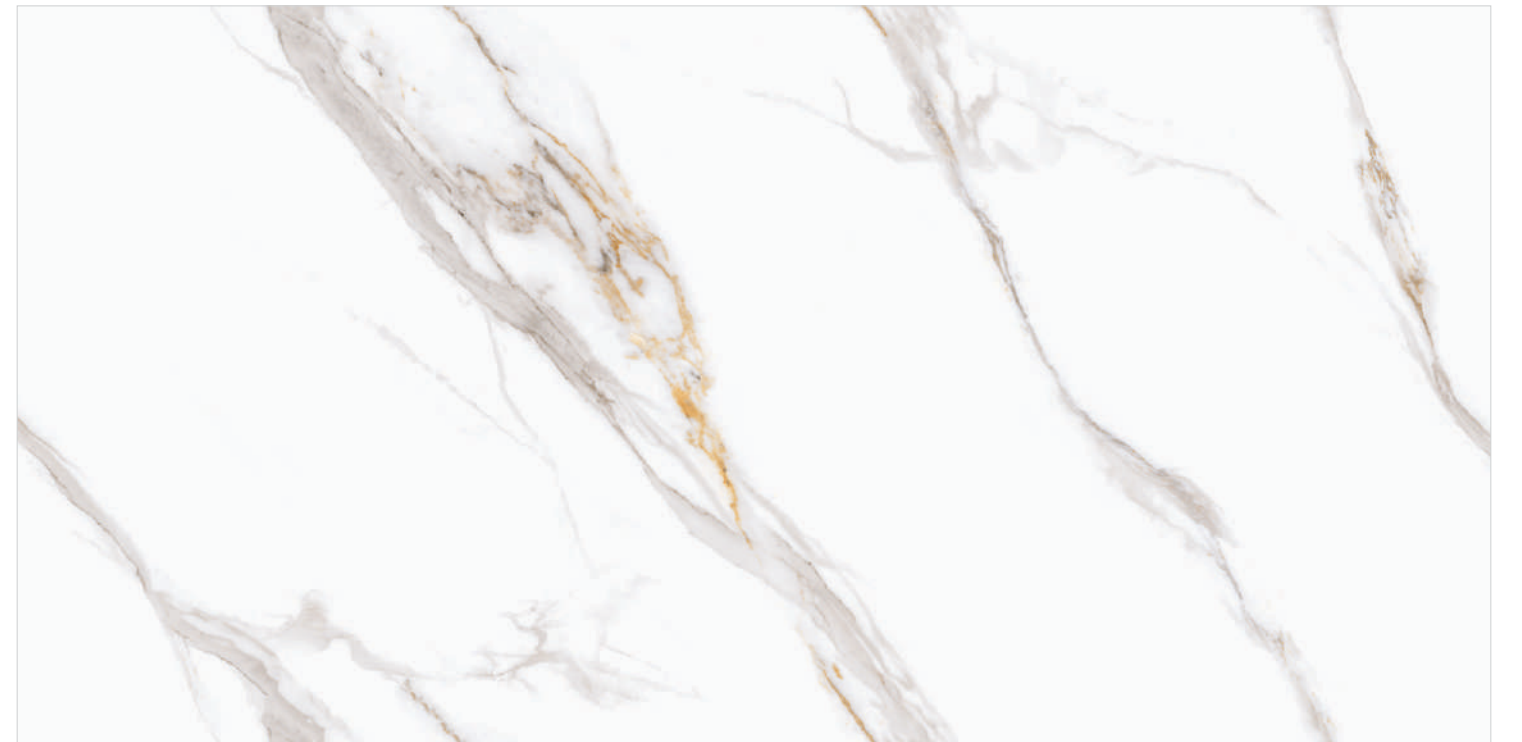

Statuario Verona

GHR



800x1600mm / 32"x64"  
9mm Thickness



ENDLESS

Wall\_Statuario Verona (Punch)  
Floor\_Statuario Verona



## MANUALLY TRANSPORTING SLAB

Only for 1/4" Slabs

### MOVING A SLAB

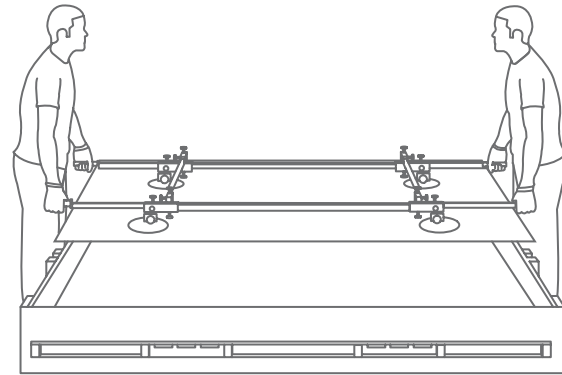
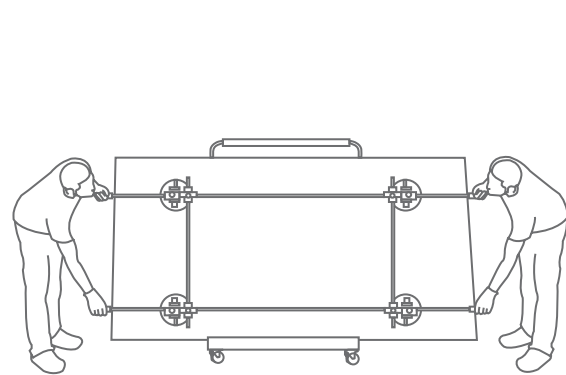

### RAISING A IMMODERATE SLAB ONTO A BENCH

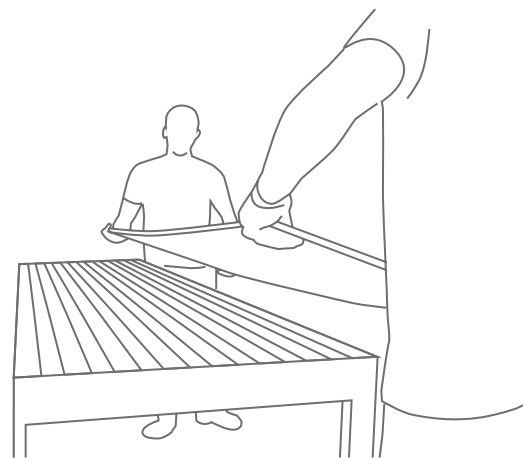

✗ INCORRECT

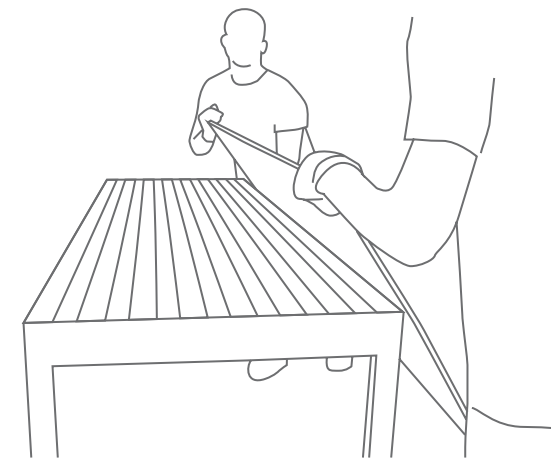

✓ CORRECT

### HANDLING IMMODERATE SLAB FOR WALL

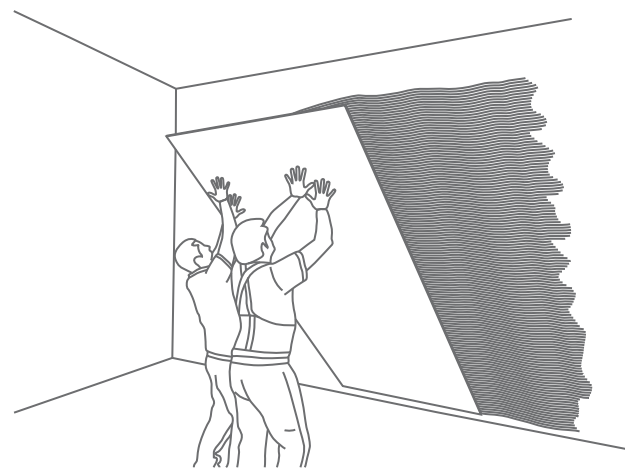

✗ INCORRECT

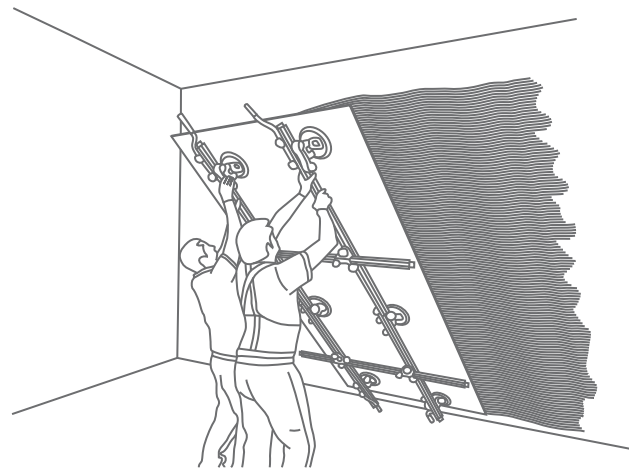

✓ CORRECT

## WORKING WITH THE VARIOUS VERSIONS OF SLAB

### CUTTING WITH DIAMOND DISCS

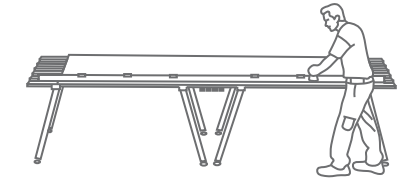
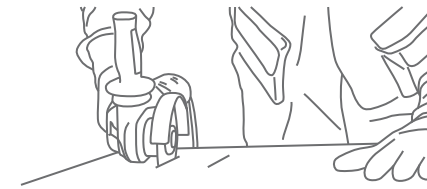

Our products can be cut using diamond discs fitted onto the hand-held electrical grinding machine. The speed of Disc rotation must be high (>10000 RPM) and should have a low feed rate (< 1 m/min). It may be required to cool the disc with water. Recommended discs are the thin types generally used for cutting porcelain stoneware. The surface should be kept on a FLAT base while cutting without any gap underneath.

### DRILLING

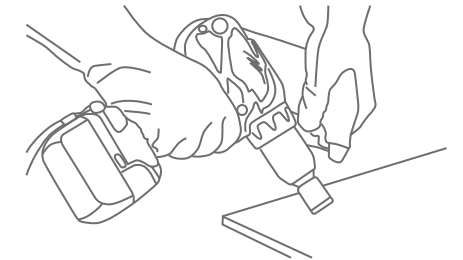
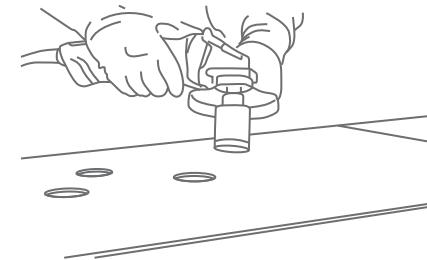

You can use cutting discs fitted to battery-operated screwdrivers or angle grinders, or electrical drills as an alternative.

### INTERNAL CUT/L-SHAPED CUT

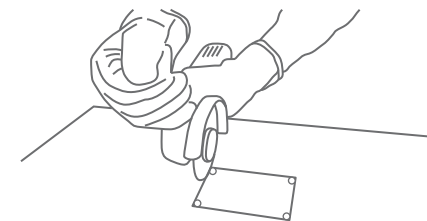

To get internal and L-shaped corners & to reduce the risk of breakage, cut 'o' at the vertex of the internal corners using bits with a radius of at least 5mm. Then cut with diamond discs, be cautious to stop moving the cutting tool forward. To drill and cut using diamond discs, and more follow the instructions provided below:

When using these tools:

- Cool the point being drilled with water
- Don't put too much pressure and bear in mind the resistance of the type of laminated stoneware you are working on
- If you are using tungsten bits, start drilling at a low speed
- If you are using drills or screwdrivers, do not select hammering mode

### EDGE-FINISHING

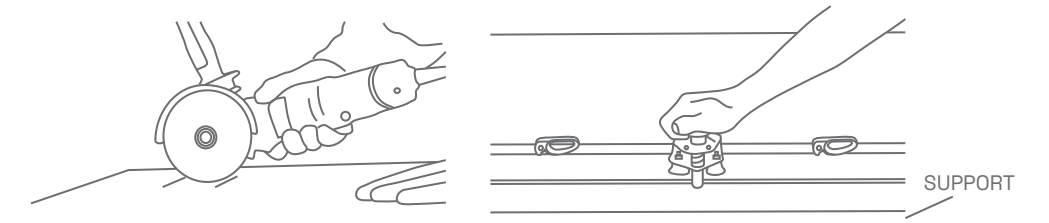
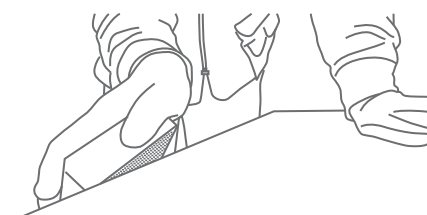

## INSTRUCTIONS FOR MANUAL INSTALLATION

SINGLE LAYER METHOD



DOUBLE-LAYER METHOD

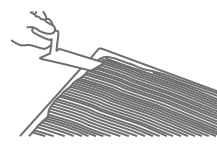

COMPRESSING THE SLAB



## IMPORTANT

All cutout corners must have a minimum diameter of 1/4". Never leave 90° angles. We recommend a radius of more than 1/4" when the kitchen design allows as it makes the countertop firmer.



✓ CORRECT



✗ INCORRECT



✗ INCORRECT



✗ INCORRECT

## CLEANING & MAINTENANCE

Our products are non porous (due to their high quality raw materials, stringent production parameters and state of the art technology), hence any dust or deposited waste cannot penetrate the surface.

For most cases only a damp cloth is sufficient for cleaning.

Regular cleaning highlights the aesthetic features of the surface and gives it exceptional shine.

For highly aggressive cleaning caused by some common food and substances follow the table below.

TYPE OF STAIN	CHEMICAL PRODUCT	EXAMPLE
Grease	Alkaline - Solvent	Detergent
Oil	Solvent	Ammonia, Baking Soda
Ink	Oxidant - Solvent	Alcohol, Liquid Bleach, Nail Paint Remover
Rust	Acid	Hydrochloric Acid, Vinegar, Red Harpic
Lime	Acid	Descaling Agents, Hydrochloric Acid
Cement	Acid	Hydrochloric Acid
Wine	Alkaline	Ammonia, Liquid Bleach
Coffee	Alkaline - Solvent	Ammonia, Liquid Bleach
Rubber	Solvent	Alcohol, Thinner
Plaster	Acid	Hydrochloric Acid
Candle Wax	Solvent	Alcohol, Thinner
Iodine	Oxidant	Liquid Bleach
Blood	Oxidant	Liquid Bleach
Ice Cream	Alkaline	Liquid Bleach

Note: It is recommended that any kind of stain needs to be cleaned immediately, as soon as possible.

## TECHNICAL SPECIFICATIONS

CHARACTERISTICS	STANDARD AS PER ISO-13006/2018 En14411 gr.bla	MOTTO VALUE	TEST METHOD
<b>Regulatory Properties</b>			
Deviation in Length & Width	+0.5%	+0.2%	ISO 10545-2
Deviation in Thickness	+5%	+5%	ISO 10545-2
Straightness of Sides	+0.5%	+0.2%	ISO 10545-2
Rectangularity	+0.5%	+0.2%	ISO 10545-2
Surface Flatness	+0.5%	+0.3%	ISO 10545-2
Colour Difference	$\Delta E < 1.00$	$\Delta E < 0.30$	ISO 10545-16
Glossiness	As per Mfg.	>90%	Gloss Meter 60°
<b>Structural Properties</b>			
Water Absorption	<0.5 %	<0.3%	ISO 10545-3
Apparent Density	As Per Mfg.	>2.20 g/cc	ISO 10545-3
<b>Massive Mechanical Properties</b>			
Modulus of Repture	Min.35N/mm <sup>2</sup>	Min.40N/mm <sup>2</sup>	ISO 10545-4
Breaking Strength	Min. 1300 N	Min. 2000 N	ISO 10545-4
Impact Resistance	As per Mfg.	Min. 0.55	ISO 10545-4
<b>Surface Mechanical Properties</b>			
Surface Abrasion Resistance	As per Mfg.	Min. class 3	ISO 10545-7
Mohs Hardness	As per Mfg.	Min. class 4	BS EN 15771
<b>Thermo Hygrometric Properties</b>			
Frost Resistance	As Per Mfg.	Frost Proof	ISO 10545-12
Thermal Shock Resistance	Min. 10 Cycle	Min. 10 Cycle	ISO 10545-9
Moisture Expansion	Max. 0.6mm/m	Max. 0.02mm/m	ISO 10545-10
Thermal Expansion	Max. 9.0 x 10 <sup>-6</sup>	Max. 6.0x10 <sup>-6</sup>	ISO 10545-8
<b>Chemical Properties</b>			
Chemical Resistance	As Per Mfg.	No Damage	ISO 10545-13
Stain Resistance	Resistant	Resistant	ISO 10545-14
<b>Safety Properties</b>			
Slip Resistance	As per Mfg.	N. A.	DIN 51130
Fire Resistance	As per Mfg.	Fire Proof	N. A.

## PACKING DETAILS

Dimension (mm)	No. of Pcs/Box	Square Feet	Weight (Approx)
800x1600mm	2 Pos.	27.5 Sq. ft	53 kg.



**MOTTO GROUP**

8-A, National Highway, Sartanpar Road, At. Sartanpar,  
Ta. Wankaner, Morbi - 363 621, Gujarat, INDIA

**Mail.** [info@mottogroup.in](mailto:info@mottogroup.in), **Web.** [www.mottogroup.in](http://www.mottogroup.in)

**Toll-free.** 1800 123 2124

**Call.** +91 95123 80072

Scan for Catalogue

