



AN EXCELLENT CHOICE



MURAL
COLLECTION



800x1600mm
9mm Thickness

INTRODUCING

INSPIRING COLLECTION

INSPIRED BY NATURE

Let harmony of class, charm & comfort revolve in your space with a magnificent collection. The collection is the culmination of fine craftsmanship and modern concepts. Discover various designs, patterns & layouts to match your vision and decor style seamlessly. In addition, the surfaces have unique appeal and class-apart features that stand out.



DISCOVER

TIMELESS STYLE

WITNESS THE REMARKABLE TRANSITION OF SPACE

Look no further to transcend your space's look from ordinary to extraordinary as you discover the latest ceramic invention. The tiles are designed with the latest technology & with unique concepts to match versatile settings. They seamlessly blend with the decor style, imparting a luxurious look & captivating allure. Above all, the rich features enhance the look of the creation.

Allow your space to evolve seamlessly from classic to contemporary style with a range of tiles in a magnificent format. The 800x1600mm format tiles create a sleek & modern aesthetic, making spaces look more dynamic and spacious.

Precisely crafted with utmost perfection, these ceramic creations are engineered for residential & commercial settings. Above all, they offer a wide range of decor possibilities to define these settings more efficiently.



800x1600mm
80x160cm

Italian Technology





A MARVEL PIECE THAT SPEAKS VOLUMES

Unravel a masterpiece that speaks through its beauty, quality, and unique characteristics. It has the ability to make a significant statement or impression within your space.

Its meticulous design and unparalleled finesse render it a symbol of architectural excellence, defining spaces with unparalleled opulence and distinction.

CAPTIVATING

COLOR RANGE



It is easy to decor every corner of your abode if you have a range of tiles with distinctive colors. Find a maximal range of tiles with tones, style, and surface design to match your vision of dream space.

The understated, ergonomic, and contemporary shades beautifully define your abode and elevate it to a new level of elegance. These shades give an intriguing effect, capturing stares.

RARE APPEAL & ASTONISHING SURFACE

Live larger than life with surfaces having a unique appeal and characterful look. They define the essence of modernity and stand as an epitome of magnificence, transforming the overall look of spaces.

These surfaces are effortless to lay in with glitz and glamorous appeal. These surfaces traverse styles, transcending time to etch an everlasting mark of elegance upon any space they adorn.

SURFACE GHR

Elevate your space to a new level of elegance with a rare and remarkable GHR surface etched with embossed designs and a sparkling touch of decorative flair. Each tile is meticulously designed to bring the artistic impression into reality.

The unique surface is inspired by the very essence of nature, attributing the luxurious charm & timeless elegance to spaces. The brilliant details enhance the look further. Revamp your space now with the exclusive **GHR surface**.

CAPTIVATING

COLOR RANGE

CONTRASTING ELEGANCE MARVELOUS APPEAL

Transform your surroundings into a thrilling scene with the dynamic energy of dual striking tones. Let vibrant hues infuse every corner, creating an elegant and thrilling scene.

Capture the timeless appeal of surfaces that blend seamlessly with versatile decor. Look no further to give your space an aesthetic makeover with a dynamic dual shade of elegance.

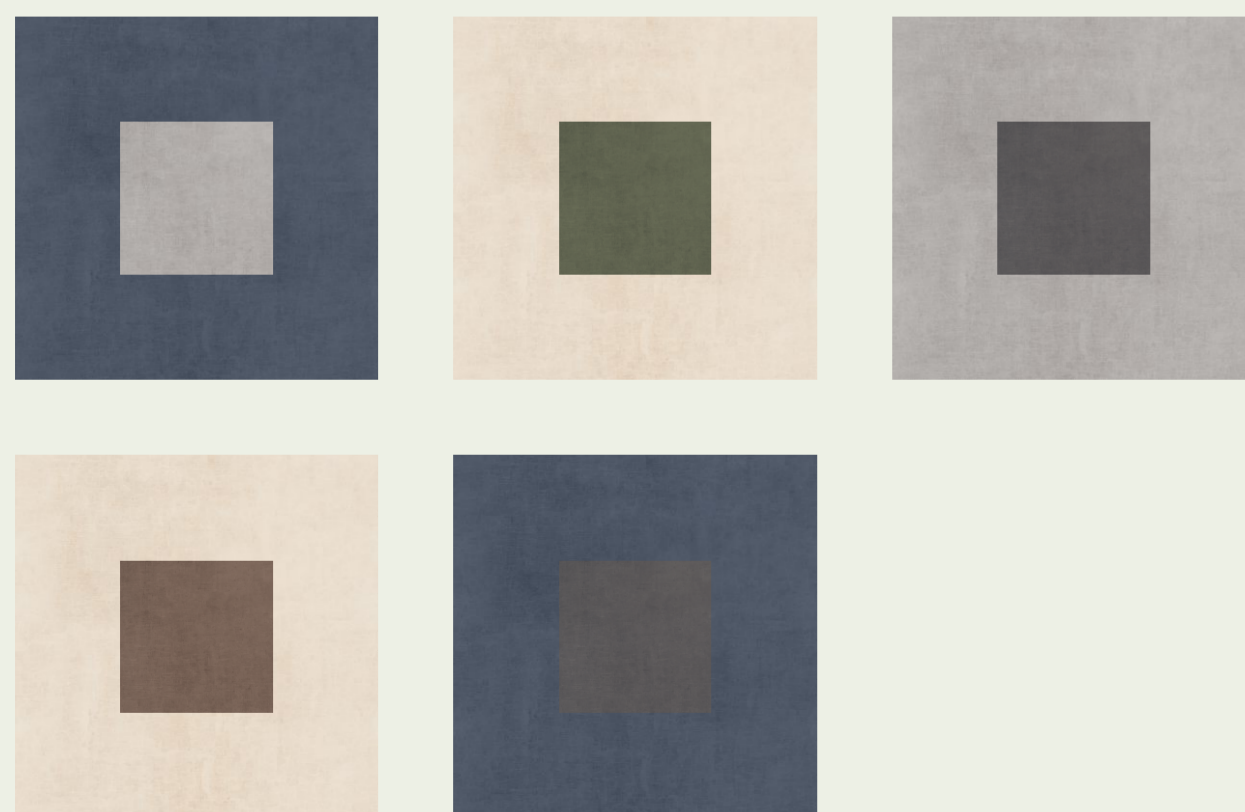

UNRAVEL

SUPERIOR FINISH

SURFACE

GHR



Italian Technology

EXCELLENT

FEATURES & THICKNESS

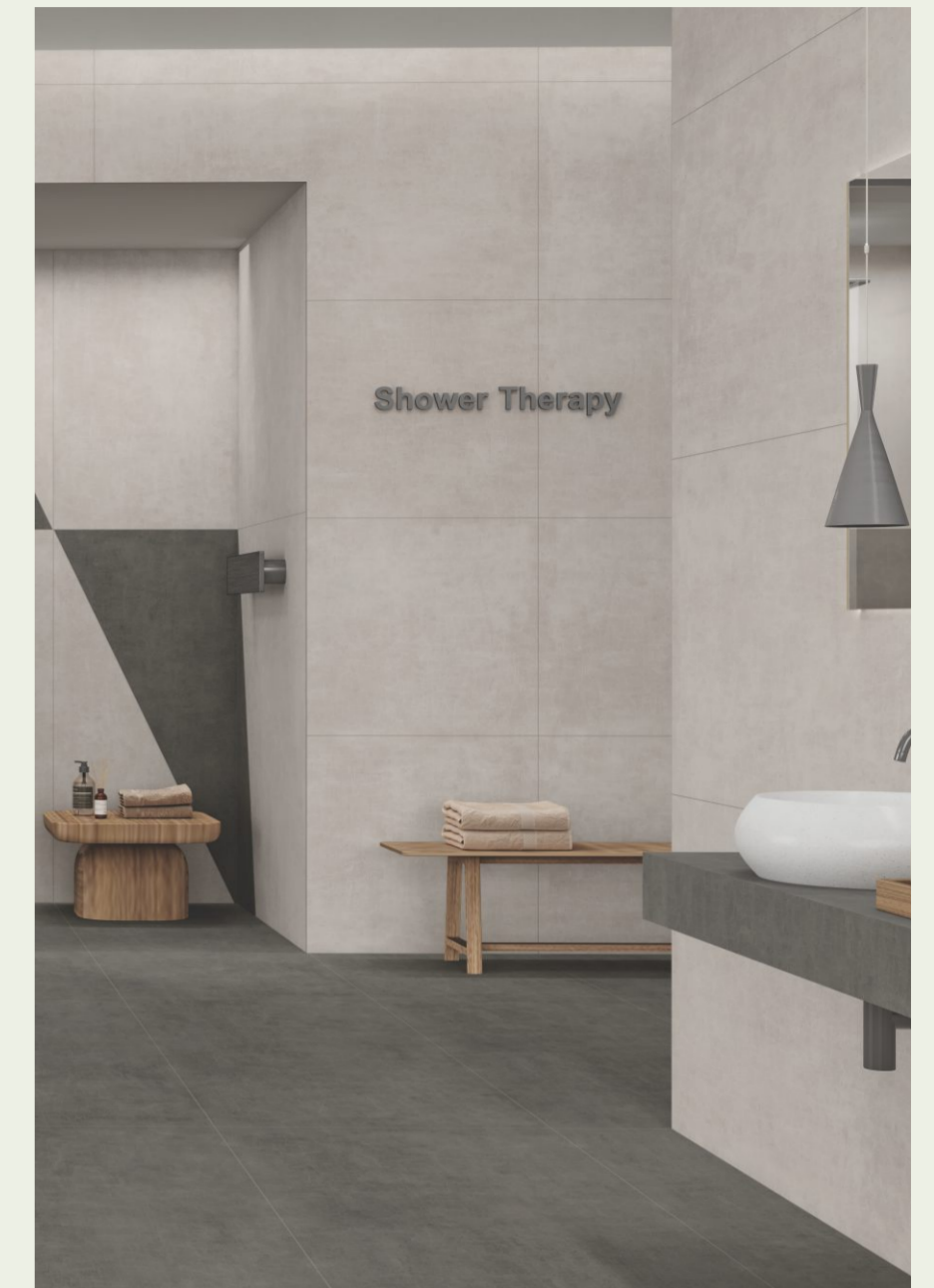

9mm Thickness

The tiles make an everlasting impression with unmatched features, style and incredible 15mm thickness.



High Resilience

The surfaces are resilient to stains, scratches, impacts, and more.



Antibacterial Surface

Non-porous surfaces boost anti-microbial properties, making them hygienic.



Sustainable

The practices at Motto are designed green to promote sustainability.



Made in India

The products of Motto are proudly Made in India and available worldwide.



Heat & Weather-Resistant

The robust surfaces stay unaffected by heat and harsh weather conditions.



Recyclable

Made thoughtfully, the surfaces are recyclable, generating less waste.



Floor
Murals Crema

Wall
Murals Crema Decor-2

A floral artwork that captures your space through its botanic elements and elevates the solids of artful drama. Make your space a mural of art forms that depict positive energy in every corner. A splendid ergonomic and functional approach to uplift your space with innovation!

Murals Crema Decor-2



Murals Crema



Size : **800x1600mm**
Finish : **GHR**
Random : **4**
Thickness: **9mm**

Color Combinations



Italian Technology |  FLEXIBLE BODY





Floor
Murals Brown

Wall
Murals Brown & Decor-2

Chic aesthetics that ensure that every inch of your space is a canvas of artistic visions. A bespoke of excellence that resonates with the contemporary standards of a qualitative approach. Enrich your space with the dynamics of modern artworks and create a classic setting.



Floor
Murals Crema

Wall
Murals Crema & Brown

Murals Brown Decor-2



Murals Brown



Size : **800x1600mm**

Finish : **GHR**

Random : **4**

Thickness: **9mm**

Color Combinations

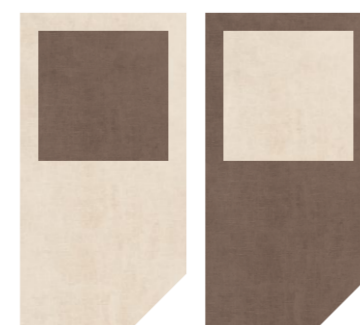

Italian Technology

 FLEXIBLE BODY





Floor
Murals Verde

Wall
Murals Verde Decor-1

A lush innovation that seamlessly integrates into your space to create an antique fair of astonishment. A space characterized by "innovation" to astonish the standards of modern designs. Experience the beauty of innovative solutions that craft your space with elegance.



Murals Verde Decor-1



Murals Verde



Size : **800x1600mm**
Finish : **GHR**
Random : **4**
Thickness: **9mm**

Color Combinations



Italian Technology |  FLEXIBLE BODY





Floor
Murals Grey

Wall
Murals Grey & Decor-2

A modern approach to create a spatial narrative that amplifies the details of the design and remains akin to the capsules of time. Witness the layer of pioneering imagination take a front seat in your space. Craft a space that is an embodiment of excellence from every angle.



Floor
Murals Gris

Wall
Murals Grey & Gris

Murals Grey Decor-2



Murals Grey



Size : **800x1600mm**
Finish : **GHR**
Random : **4**
Thickness: **9mm**

Color Combinations

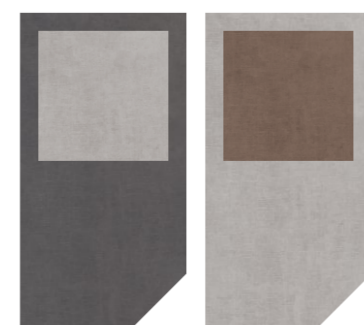

Italian Technology

 FLEXIBLE BODY





Floor
Murals Gris

Wall
Murals Gris & Decor-1

Let the fauna of flourishing designs recreate a space of elegance where perfection meets contemporary standards of design. Bring to your space a symbol of innovation that creates an alluring impact. A modern artwork that adds a backslash of excitement to your space!



Murals Gris Decor-1



Murals Gris



Size : **800x1600mm**
Finish : **GHR**
Random : **4**
Thickness: **9mm**

Color Combinations

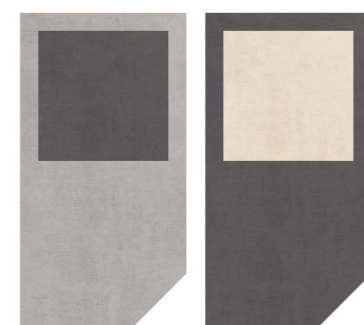

Italian Technology

 FLEXIBLE BODY





Floor
Murals Blue

Wall
Murals Blue & Decor-2

Let the blue polish of the panorama make a confluence of modernism and traditions. An interconnected layout of creativity that finds its roots in the glory of ingenuity. Make your space an inviting abode of scintillating designs that reflect the dimensions of art and allure.





Floor
Murals Blue

Wall
Murals Blue & Grey

Murals Blue Decor-2



Murals Blue



Size : **800x1600mm**
Finish : **GHR**
Random : **4**
Thickness: **9mm**

Color Combinations

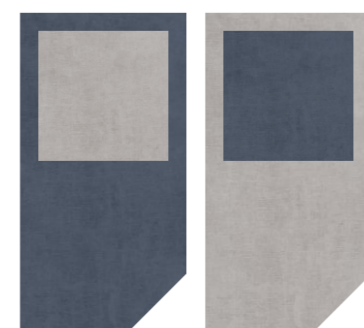

Italian Technology

 FLEXIBLE BODY



MANUALLY TRANSPORTING SLAB

Only for 1/4" Slabs

MOVING A SLAB

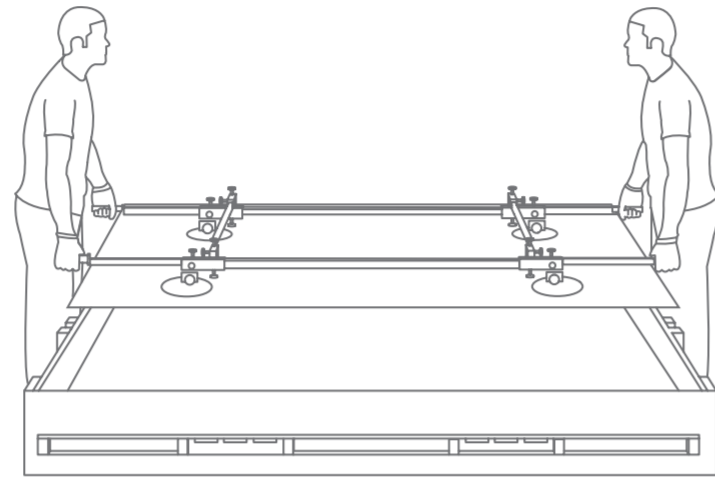
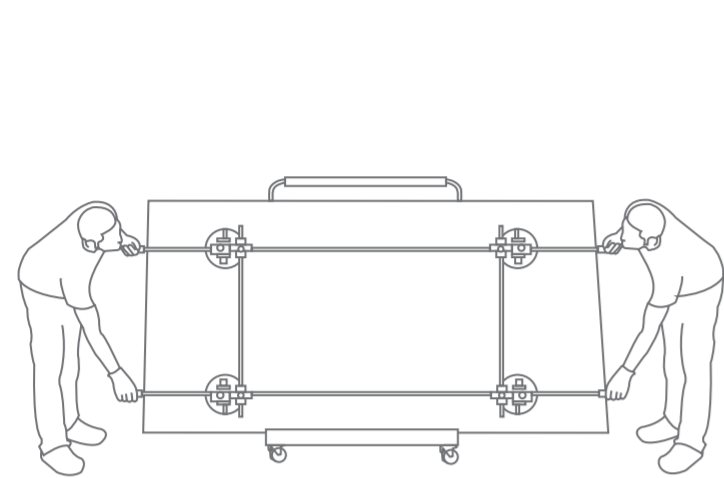

RAISING A IMMEDIATE SLAB ONTO A BENCH

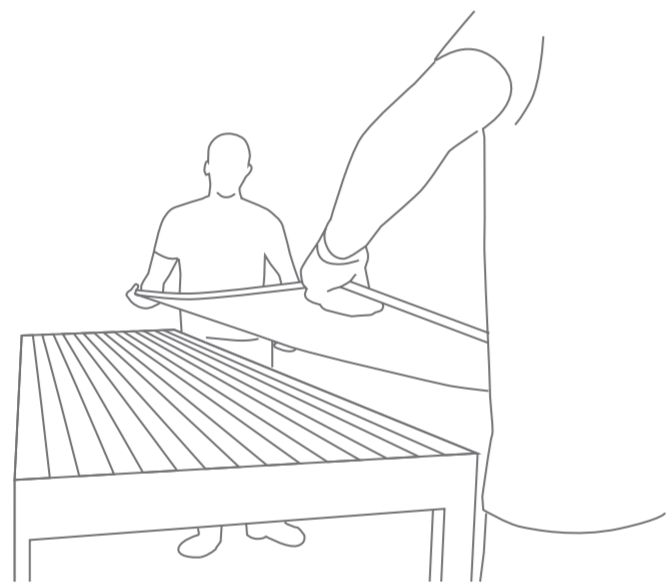

✗ INCORRECT

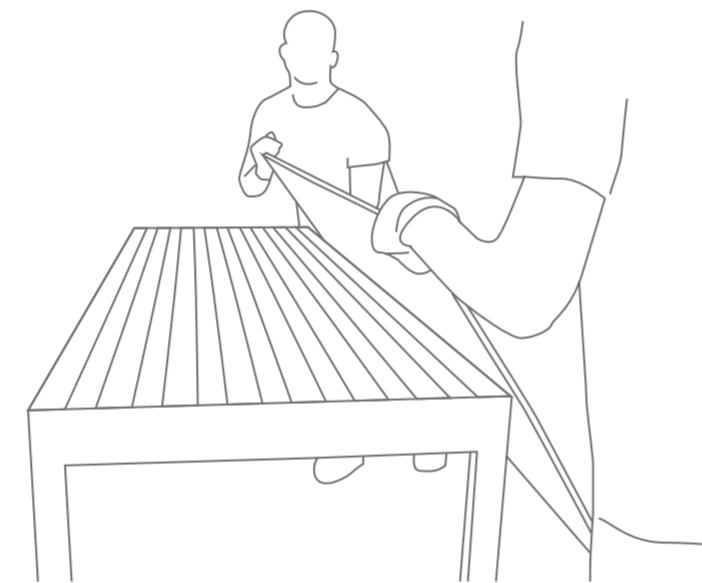

✓ CORRECT

HANDLING IMMEDIATE SLAB FOR WALL

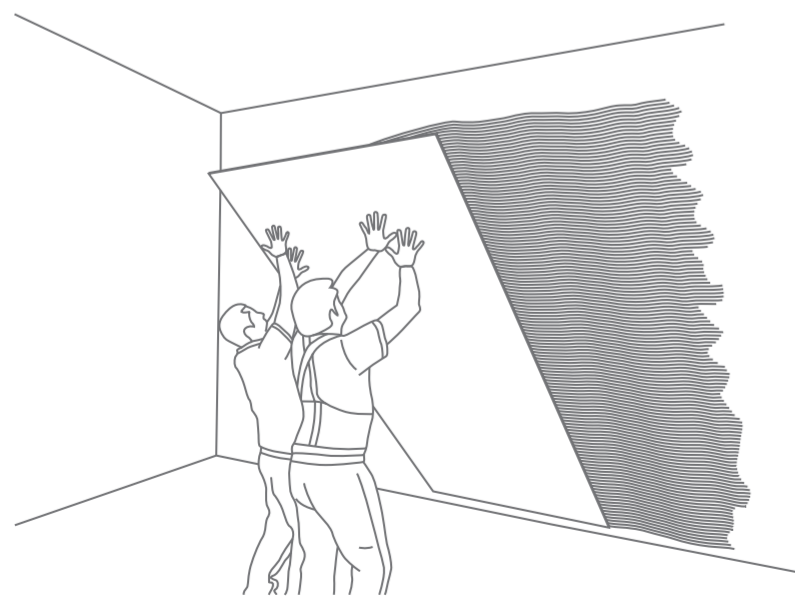

✗ INCORRECT

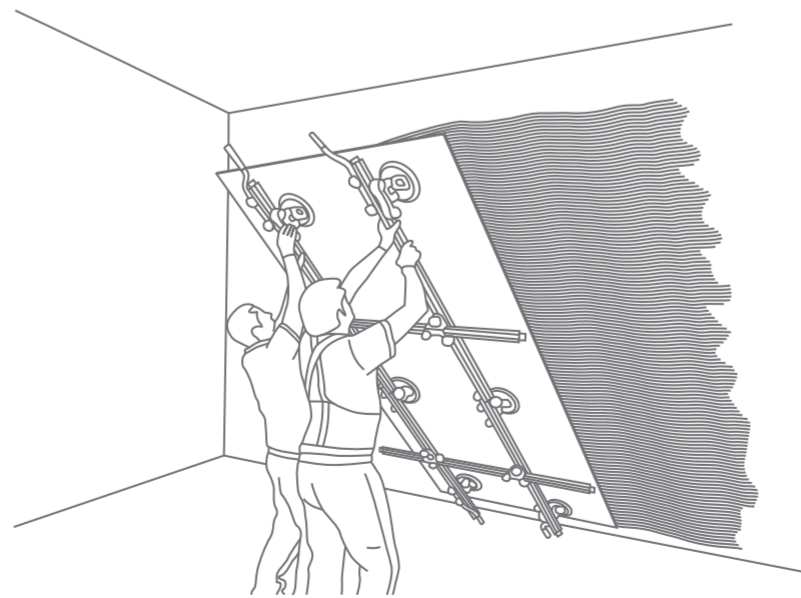

✓ CORRECT

WORKING WITH THE VARIOUS VERSIONS OF SLAB

CUTTING WITH DIAMOND DISCS

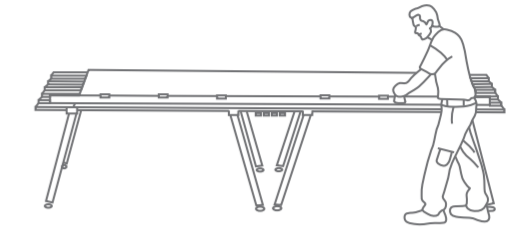

Our products can be cut using diamond discs fitted onto the hand-held electrical grinding machine. The speed of Disc rotation must be high (>10000 RPM) and should have a low feed rate (< 1 m/min). It may be required to cool the disc with water. Recommended discs are the thin types generally used for cutting porcelain stoneware. The surface should be kept on a FLAT base while cutting without any gap underneath.

DRILLING

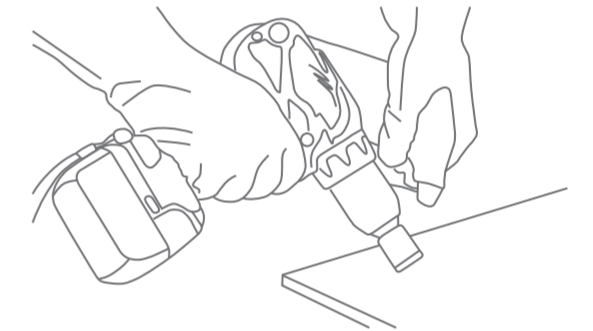
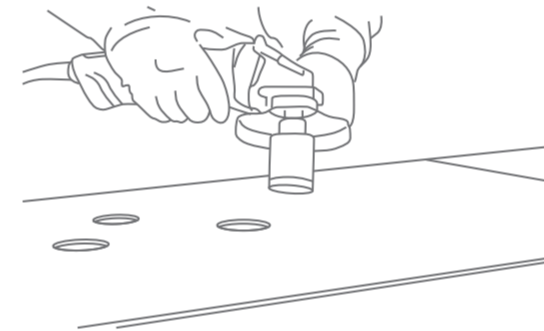

You can use cutting discs fitted to battery-operated screwdrivers or angle grinders, or electrical drills as an alternative.

INTERNAL CUT/L-SHAPED CUT

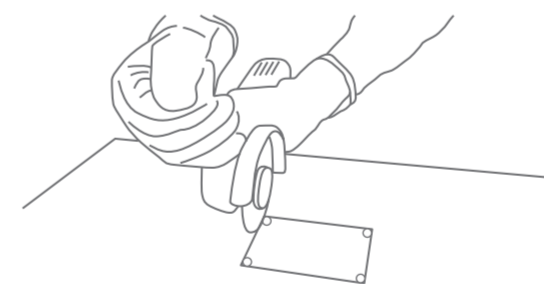

To get internal and L-shaped corners & to reduce the risk of breakage, cut 'o' at the vertex of the internal corners using bits with a radius of at least 5mm. Then cut with diamond discs, be cautious to stop moving the cutting tool forward. To drill and cut using diamond discs, and more follow the instructions provided below:

- When using these tools:
- Cool the point being drilled with water
 - Don't put too much pressure and bear in mind the resistance of the type of laminated stoneware you are working on
 - If you are using tungsten bits, start drilling at a low speed
 - If you are using drills or screwdrivers, do not select hammering mode

EDGE-FINISHING

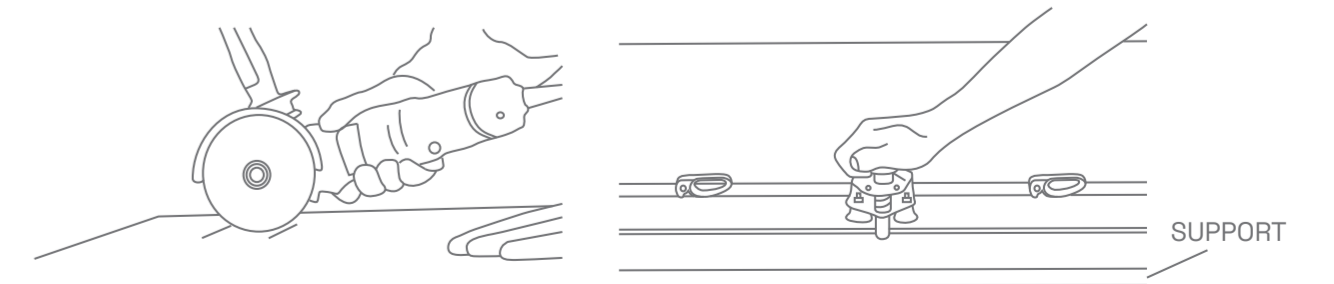

SUPPORT

INSTRUCTIONS FOR MANUAL INSTALLATION

SINGLE LAYER METHOD

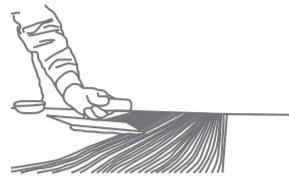

DOUBLE-LAYER METHOD

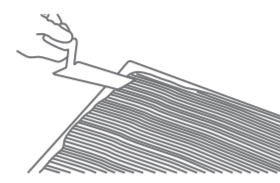

COMPRESSING THE SLAB

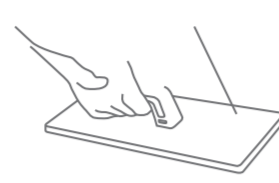

IMPORTANT

All cutout corners must have a minimum diameter of 1/4". Never leave 90° angles. We recommend a radius of more than 1/4" when the kitchen design allows as it makes the countertop firmer.



✓ CORRECT



✗ INCORRECT



✗ INCORRECT



✗ INCORRECT

CLEANING & MAINTENANCE

Our products are non porous (due to their high quality raw materials, stringent production parameters and state of the art technology), hence any dust or deposited waste cannot penetrate the surface.

For most cases only a damp cloth is sufficient for cleaning.

Regular cleaning highlights the aesthetic features of the surface and gives it exceptional shine.

For highly aggressive cleaning caused by some common food and substances follow the table below.

TYPE OF STAIN	CHEMICAL PRODUCT	EXAMPLE
Grease	Alkaline - Solvent	Detergent
Oil	Solvent	Ammonia, Baking Soda
Ink	Oxidant - Solvent	Alcohol, Liquid Bleach, Nail Paint Remover
Rust	Acid	Hydrochloric Acid, Vinegar, Red Harpic
Lime	Acid	Descaling Agents, Hydrochloric Acid
Cement	Acid	Hydrochloric Acid
Wine	Alkaline	Ammonia, Liquid Bleach
Coffee	Alkaline - Solvent	Ammonia, Liquid Bleach
Rubber	Solvent	Alcohol, Thinner
Plaster	Acid	Hydrochloric Acid
Candle Wax	Solvent	Alcohol, Thinner
Iodine	Oxidant	Liquid Bleach
Blood	Oxidant	Liquid Bleach
Ice Cream	Alkaline	Liquid Bleach

Note: It is recommended that any kind of stain needs to be cleaned immediately, as soon as possible.

TECHNICAL SPECIFICATIONS

CHARACTERISTICS	STANDARD AS PER ISO-13006/2018 En14441 gr.bla	MOTTO VALUE	TEST METHOD
Regulatory Properties			
Deviation in Length & Width	+0.5%	+0.2%	ISO 10545-2
Deviation in Thickness	+5%	+5%	ISO 10545-2
Straightness of Sides	+0.5%	+0.2%	ISO 10545-2
Rectangularity	+0.5%	+0.2%	ISO 10545-2
Surface Flatness	+0.5%	+0.3%	ISO 10545-2
Colour Difference	$\Delta E < 1.00$	$\Delta E < 0.30$	ISO 10545-16
Glossiness	As per Mfg.	>90%	Gloss Meter 60'
Structural Properties			
Water Absorption	<0.5 %	<0.3%	ISO 10545-3
Apparent Density	As Per Mfg.	>2.20 g/cc	ISO 10545-3
Massive Mechanical Properties			
Modulus of Repture	Min.35N/mm ²	Min.40N/mm ²	ISO 10545-4
Breaking Strength	Min. 1300 N	Min. 2000 N	ISO 10545-4
Impact Resistance	As per Mfg.	Min. 0.55	ISO 10545-4
Surface Mechanical Properties			
Surface Abrasion Resistance	As per Mfg.	Min. class 3	ISO 10545-7
Mohs Hardness	As per Mfg.	Min. class 4	BS EN 15771
Thermo Hygrometric Properties			
Frost Resistance	As Per Mfg.	Frost Proof	ISO 10545-12
Thermal Shock Resistance	Min. 10 Cycle	Min. 10 Cycle	ISO 10545-9
Moisture Expansion	Max. 0.6mm/m	Max. 0.02mm/m	ISO 10545-10
Thermal Expansion	Max. 9.0×10^{-6}	Max. 6.0×10^{-6}	ISO 10545-8
Chemical Properties			
Chemical Resistance	As Per Mfg.	No Damage	ISO 10545-13
Stain Resistance	Resistant	Resistant	ISO 10545-14
Safety Properties			
Slip Resistance	As per Mfg.	N. A.	DIN 51130
Fire Resistance	As per Mfg.	Fire Proof	N. A.

PACKING DETAILS

Dimension (mm)	No. of Pcs/Box	Square Feet	Weight (Approx)
800x1600mm	2 Pcs.	27.5 Sq. ft	53 kg.



MOTTO GROUP

8-A, National Highway, Sartanpar Road, At. Sartanpar,
Ta. Wankaner, Morbi - 363 621, Gujarat, INDIA

Mail. info@mottogroup.in, **Web.** www.mottogroup.in

Toll-free. 1800 123 2124

Call. +91 95123 80072